

# QBiX-Pro-ARUA225H-A1

Industrial system with Intel® Core™ Ultra 5 Processor 225U / Fanless Design/ Dual Channel DDR5 / 2 x HDMI



## Features

- System Size: 178W x 125D x 52.7H (mm)
- Intel® Core™ Ultra 5 Processor 225U
- Dual Channel DDR5, 2 x SO-DIMMs / CSO-DIMMs
- 1 x COM Port (RS-232/422/485 & RI/5V/12V)
- 2 x COM Ports (RS-232/422/485)
- 1 x Remote control
- 2 x 2.5GbE LAN Ports
- Onboard TPM v2.0

## Specifications

Dimension	System Size : 178W x 125D x 52.7H (mm)
CPU	Intel® Core™ Ultra 5 Processor 225U Intel® 3, 12 cores, 2P+8E+2LPE, 14 threads, up to 4.8 GHz
Chipset	SoC
Memory	2 x DDR5 SO-DIMM sockets, Max. Capacity 96 GB Support Dual Channel DDR5 5600 MHz memory modules or 2 x DDR5 CSO-DIMM sockets, Max. Capacity 128 GB Support Dual Channel DDR5 6400 MHz memory modules
Ethernet	2 x 2.5GbE LAN Ports (Intel® I226V & I226LM)
Graphic support	Integrated Graphics Processor - Intel® Graphics: 2 x HDMI 2.1 ports, supporting a maximum resolution of 7680x4320 @60Hz (HDMI 2 port support HDMI CEC)  (2 independent display outputs)

Audio	Realtek® ALC269
Storage	1 x 2.5" HDD/SSD (SATA 6Gb/s)
Expansion Slots	1 x 2280 M.2 M-Key (PCIe Gen4x4, SATA 6Gb/s) 1 x 2230 M.2 E-Key (WiFi/BT) 1 x Full-size Mini PCIe with SIM slot
Front I/O	2 x RJ45 LAN Ports 4 x USB 3.2 Gen 2x1 2 x HDMI 1 x Power button with LED 1 x HDD LED 1 x COM Port (RS-232/422/485 & RI/5V/12V) 1 x External Antenna Hole (Optional)
Rear I/O	2 x USB 2.0 2 x COM Ports (RS-232/422/485) 1 x GPIO (8 bits) 1 x Combo Audio Jack (Headphone & Headset) 1 x Remote control 1 x 3-pin Terminal Block
Side I/O	2 x External Antenna Holes (Optional)
TPM	Onboard TPM 2.0 security chip INFINEON SLB9672XU2.0
Power	+9V~36VDC (Full Range)
Operation temperature	Operating temperature: 0°C to 50°C Operating humidity: 40°C @ 20-95% (non-condensing) Non-operating temperature: -40°C to 85°C Non-operating humidity: 60°C @ 95% (non-condensing) Use wide temperature range memory and storage
Vibration During Operation	Operation: IEC 60068-2-64, 3 Grms, random, 5 ~ 500 Hz, 1 hr / Per Axis, with SSD/M.2 2280 Non-operation: IEC 60068-2-6, 2 G, Sine, 10 ~ 500 Hz, 1 Oct/min, 1 hr / Per Axis
Shock During Operation	Operation: IEC 60068-2-27, 50 G, half sine, 11 ms duration, with SSD
Mounting	Wall mount P/N: 25HB2-CGAA20-CHR x 1 (Optional) VESA 75/100 P/N: 25HB1-TPL021-S8R x 1 + 12KSZ-000001-00R x 1 (Screw) (Optional)

GIGAIPC reserves the right to modify or change technical data without prior notice.

## Dimension

Unit: mm

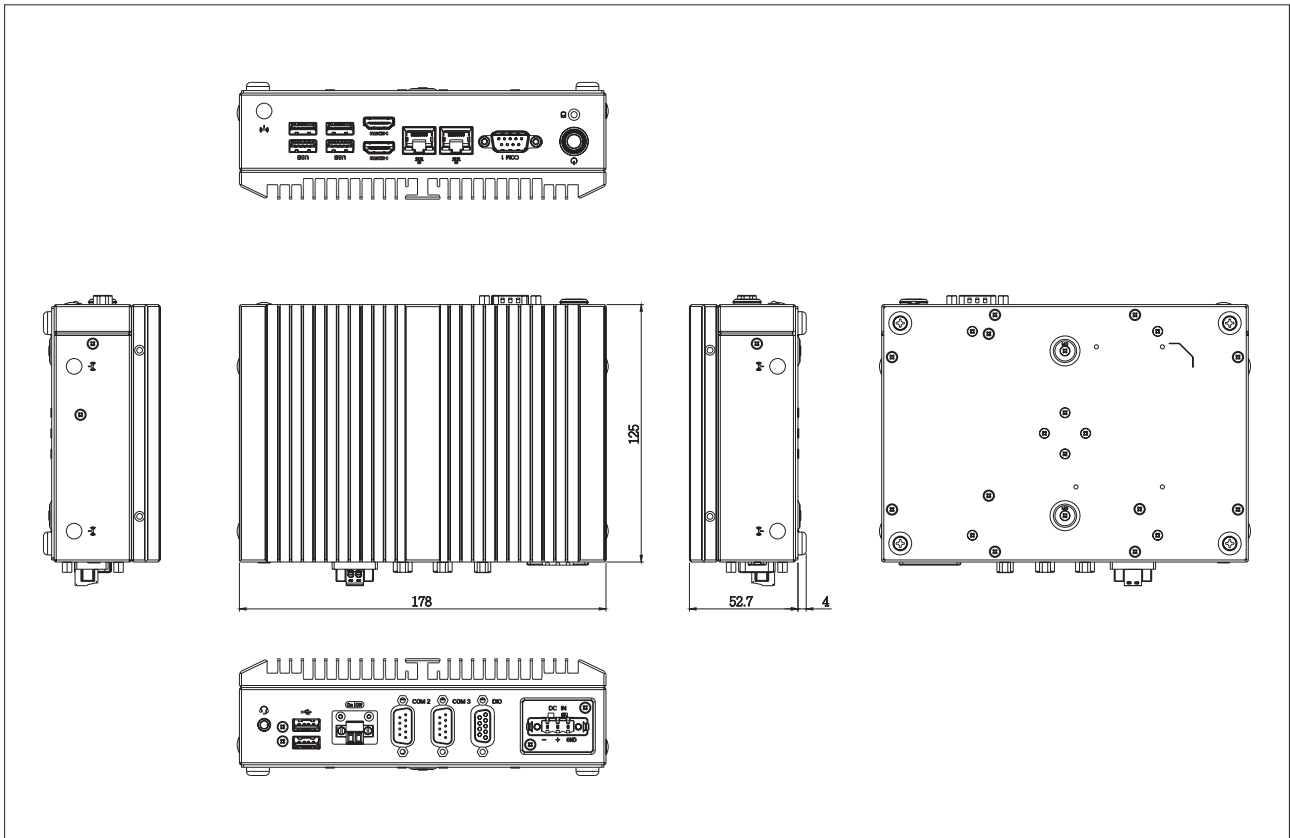

## Packing Content

- Carton size: 505 x 333 x 231 (mm)
- Packing Capacity: 5pcs
- Single Box size: 313 x 191 x 95 (mm)
- Including:
  - Screw I Head for 2.5" HDD M3x8L x 4 (P/N: 25KSG-130081-K1R)
  - Thermal Pad for Memory x 1 (P/N: 25ST3-200086-T5R)
  - 2-pin Terminal Blocks Male Plug x 1 (P/N: 25I00-EC3812-D2R)
  - SATA Cable x 1 (P/N: 25CRI-070000-S9R)
  - 3-pin Terminal Blocks Male Plug x 1 (P/N: 25I00-5ESDV0-D2R)

## Order Information

- System : 6BQP225UAMR-SI (Box packing)

2026/04/30

GIGAIPC reserves the right to modify or change technical data without prior notice.